

M150L



- ▶ Medium vacuum levels to 91 -kPa
- ▶ Compact size and light weight compared to conventional mechanical pumps
- ▶ Operates at as low as 0.34 MPa
- ▶ Good for applications where little or no leakage is present

Supplied with vacuum gauge and manometer.

Technical data

Description	Unit	Value
Feed pressure, max.	MPa	0.7
Noise level, with silencer	dBA	64-78
Temperature range	°C	-20-80
Weight	g	4100-4600
Material		Al, PPS, NBR, SS

Feed pressure MPa	Air consumption NI/s	Vacuum flow (NI/s) at different vacuum levels (-kPa)										Max vacuum -kPa
		0	10	20	30	40	50	60	70	80	90	
0.60	18.0	30	18.8	11.1	9.8	8.2	6.4	3.8	1.3	0.38		89
0.34	11.3	26	13.8	10.3	6.5	3.8	2.9	2.2	1.5	0.67	0.050	91

Evacuation time

Feed pressure MPa	Air consumption NI/s	Evacuation time (s/l) to reach different vacuum levels (-kPa)										Max vacuum -kPa
		10	20	30	40	50	60	70	80	90		
0.60	18.0	0.006	0.014	0.022	0.030	0.050	0.070	0.11	0.35		89	
0.34	11.3	0.007	0.014	0.025	0.050	0.075	0.11	0.17	0.28	0.76	91	

Blow flow

Feed pressure MPa	Air consumption NI/s	Blow flow (NI/s) at different pressure levels (kPa)												Max pressure kPa
		0	10	20	30	40	50	60	70	80	90	100	110	
0.60	18	47.8	36.8	33.2	32.5	29.9	27.0	24.4	24.4	24.4	24.0	22.5	20.7	110

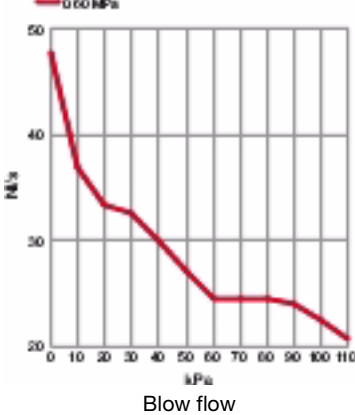
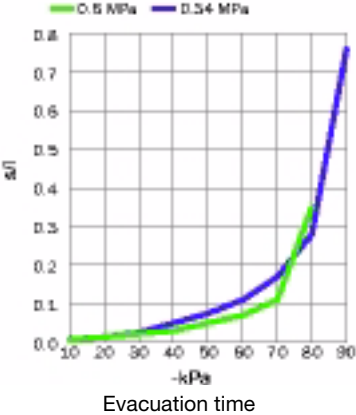
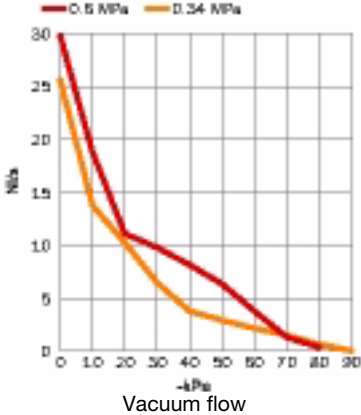

Classic MP

Ordering information

Description	Art. No.
Vacuum pump CLASSIC MP M150L, conn. V, NBR sealings	0103762
Vacuum pump CLASSIC MP M150L, conn. V, NBR sealings, complete with mounting brackets and silencer	0104160

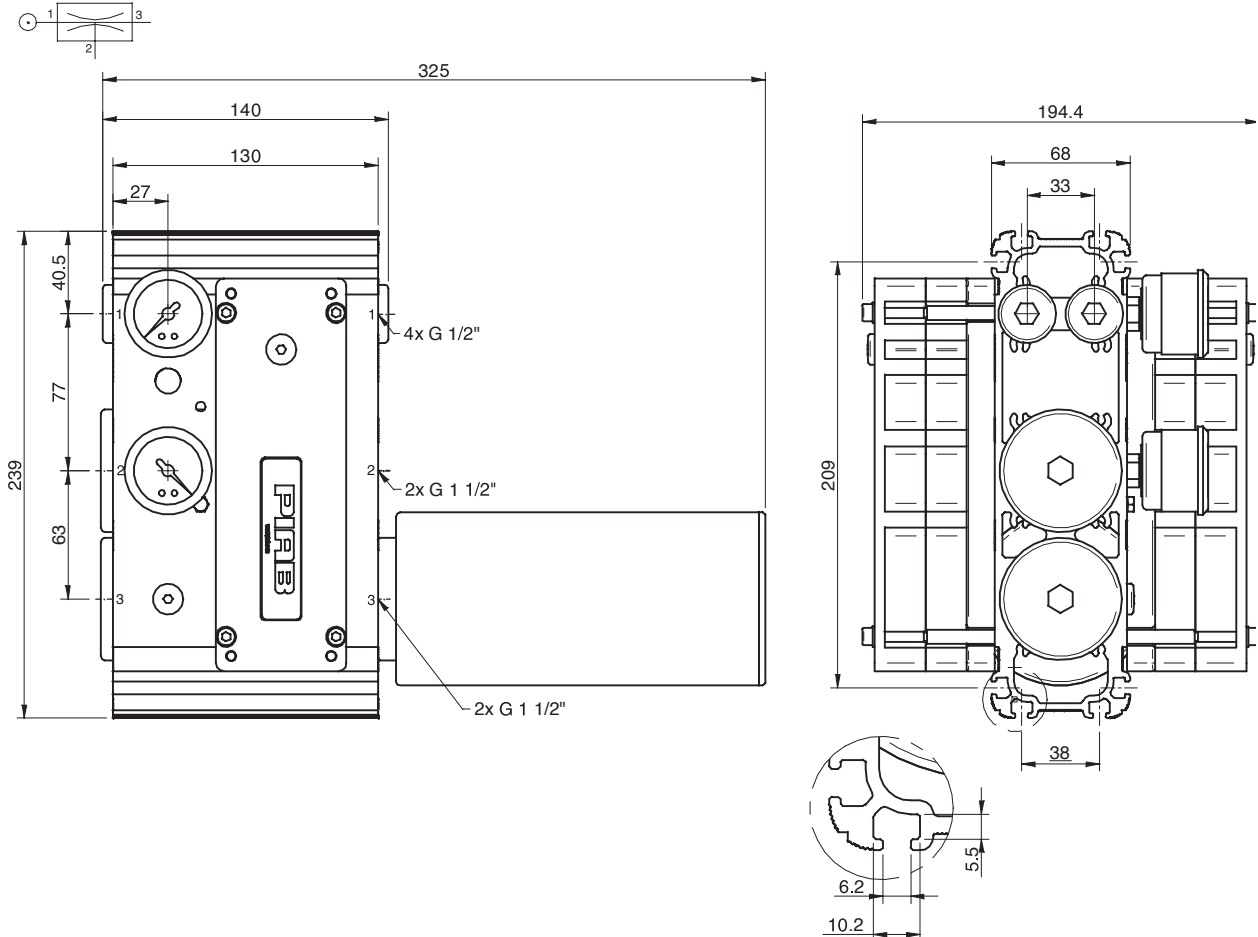

Ordering information, accessories

Description	Art. No.
Sealing kit CLASSIC MP, NBR	0104634

For CLASSIC MP 150–240 1x 0104634, for CLASSIC MP 300–480 2x 0104634. The sealing kit includes flap valves, gaskets, compressed-air filters and O-rings.