

Pleated rod filter Ø125 L=610 cpl, 0124881



- Suitable for fine powders, for example toner.
- Fulfils the requirements of FDA, EC No. 1935/2004 and EC No. 10/2011.
- The grey pleated rod filter is antistatic and in compliance with ATEX.

Общее

Площадь фильтра	4500 cm ²
Материал	PUR, PE, PTFE, ASTM 301
Particle size	0,5 µm
Макс. температура.	70 °C
Weight	2,66 kg

Измерение

Внешний диаметр	125,2 – 137 mm
Длина	610 mm (L)

Масштабные чертежи

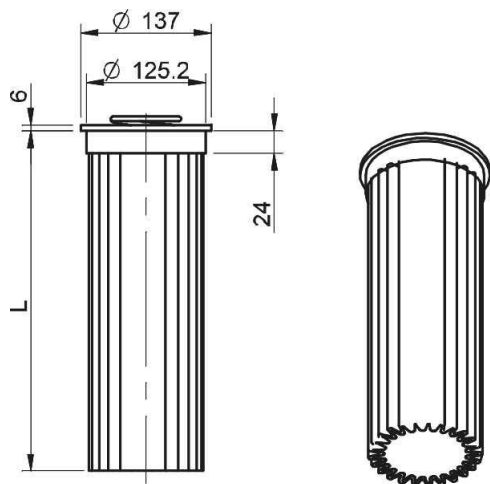

Аксессуары

	Номер изделия
Filter seal 125, Q FCM	0206455